

TOPCAT[®]

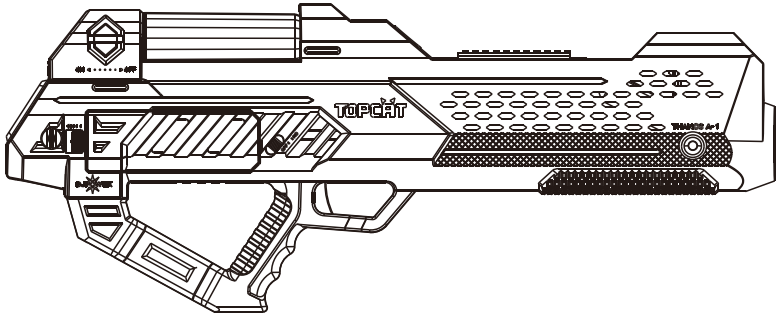

THANOS A-1 FOG GUN

USE MANUAL

GUANGZHOU DJPOWER ELECTRONIC TECHNOLOGY CO.,LTD

1 BEFORE YOU BEGIN

1.1 What Is Included



A-1 Fog Gun × 1 Bottom Base × 1 Power cord × 1 Battery × 1 Strap × 1 Warranty Card × 1
Fluid bottle × 2

1.2 Unpacking Instructions

Carefully unpack the product immediately and check the container to make sure all the parts are in the package and are in good condition.

If the box or the contents (the product and included accessories) appear damaged from shipping, or show signs of mishandling, notify the carrier or dealer/seller immediately. In addition, keep the box and contents for inspection.

1.3 Symbols

Symbol	Meaning
	Caution Critical installation, configuration, or operation information. Not following these instructions may make the product not work, cause damage to the product, or cause harm to the operator.
	Important Important installation or configuration information. Failure to comply with this information may keep the product from working correctly.
	Information Useful information.

1.4 Disclaimer

The information and specifications contained in this User Manual are subject to change without notice. DJPOWER assumes no responsibility or liability for any errors or omissions and reserves the right to revise or to create this manual at any time.

Copyright © 2019 DJPOWER. All rights reserved.

1.5 Safety Notes

Please read the following Safety Notes carefully before working with the product. The notes include important safety information about installation, usage, and maintenance.

1.5.1 Personal Safety

- Always connect the product to a grounded circuit to avoid the risk of electrocution.
- Make sure that children, unauthorized people and animals do not obtain access to the machine.

1.5.2 Mounting and Rigging

- The product is for indoor use! To prevent risk of fire or shock, do not expose the product to rain or moisture.
- CAUTION: When transferring product from extreme temperature environments, (e.g. cold truck to warm humid ballroom) condensation may form on the internal electronics of the product. To avoid causing a failure, allow product to fully acclimate to the surrounding environment before connecting it to power.
- Do not mount the product on a flammable surface (linoleum, carpet, wood, paper, carton, plastic, etc.).
- Do not use in a confined space. Always install the product in a location with adequate ventilation, at least 20 in (50 cm) from adjacent surfaces.
- Be sure that no ventilation slots on the product's housing are blocked.

1.5.3 Power and Wiring

- Always make sure that the voltage of the outlet to which you are connecting the product is within the range stated on the decal or rear panel of the product.
- Make sure the power cord is not crimped or damaged.
- Do not connect the machine to the dimming controller or rheostat.
- Never disconnect the product from power cord by pulling or tugging on the cord.
- To eliminate unnecessary wear and improve its lifespan, during periods of non-use completely disconnect the product from power via breaker or by unplugging it.

1.5.4 Operation

- Do not operate this product if you see damage to the housing or cables. Have the damaged parts replaced by an authorized technician at once.
- Make sure there are no flammable materials close to this product while it is operating.
- Do not cover or plug the output nozzle during operation.
- Do not cover the vents always.
- Do not use the product as a space heater.
- Never carry the product by the power cord or any moving part. Always use the handles.
- Empty the storage bin before transporting the product.
- The maximum ambient temperature (Ta) is 104 °F (40 °C). Do not operate the product at higher temperatures.
- Always disconnect the product from the power source before cleaning.
- This product contains no user-serviceable parts. Any reference to servicing in this User Manual will only apply to properly trained, certified technicians. Do not open the housing or attempt any repairs which can lead to damage or malfunction.
- In the event of a serious operating problem, stop using the product immediately.
- Use only DJPOWER Professional fog fluid PRO-Q

2 INTRODUCTION

2.1 Description

TOPCAT Thanos A-1 is the world's first rechargeable high-speed Fog Gun. It is very easy to use by consuming fog fluid instead of connecting to gas cylinder to create awesome effects. Different from the traditional CO2 gun used in the entertainment venues, consuming carbon dioxide, inconvenient and costly to use, A-1 fog gun is fully electric and with long full burst continuous for 35s. The rechargeable battery inside the gun make it portable to use without the limitation of power cable any more. The output strength and speed are enhanced by a high-speed small fan which can also be controlled independently to create strong wind to interact with audiences for fun. With TOPCAT unique Thanos A-1 fog gun, have fun and lead the new fashion.

2.2 Features

- Designed with high-speed fan to help enhance fog output strength;
- Continuous full burst up to 35s;
- Specially designed bullet-shape fluid tank, easy to replace or refill;
- Coated with special insulation layer to avoid overheat;
- Two charging rooms in bottom base for battery charging;
- Quick-change function for the rechargeable battery.

2.3 Product Overview

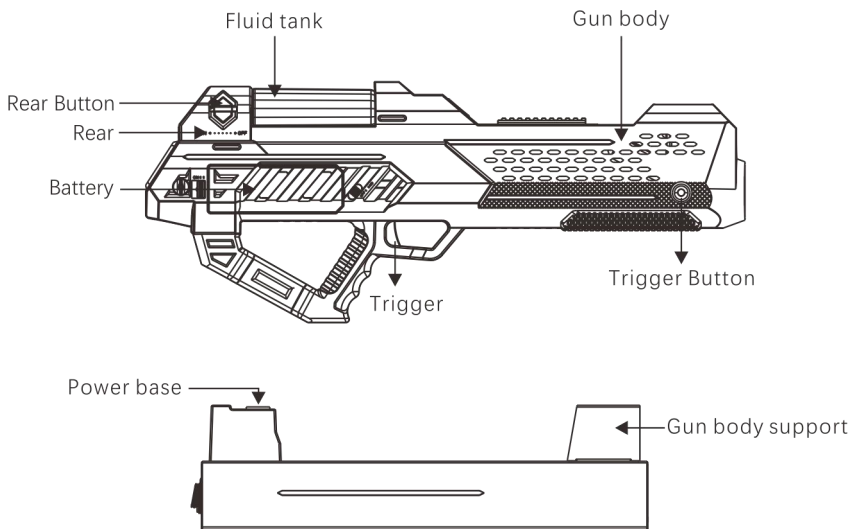

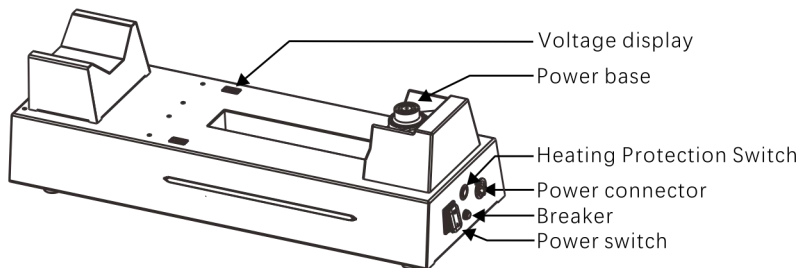
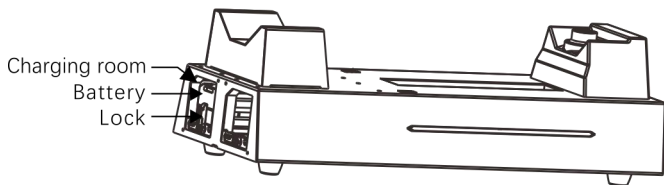

2.4 Product Dimensions

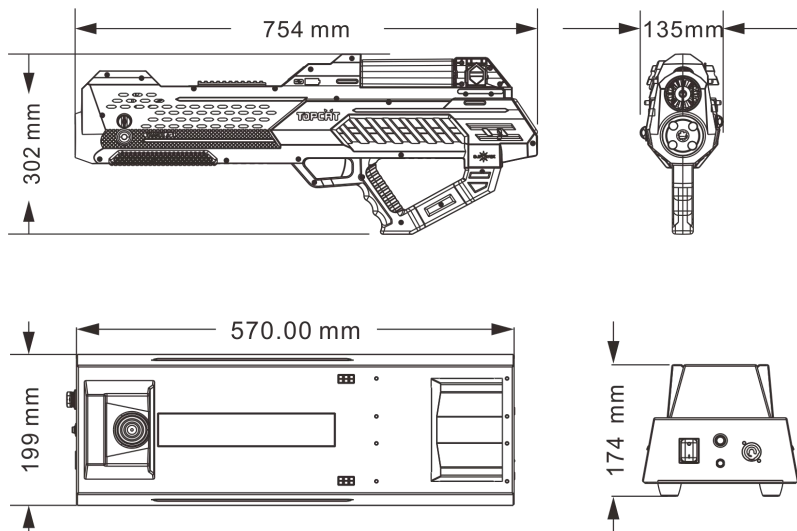

3 TECHNICAL SPECIFICATIONS

AC Power	Input Voltage & Rate	AC 220-240 V, 50/60 Hz
	Current Limiter Type	Breaker
	Current Limiter Specifications	6A, 250V
	Total Power Consumption	1,200 W

Heating	Heat Up Time	Appr. 7 min
Light Source	LED Color	Nozzle LED: RGB Gun Body LED: RGBW
	LED Type	Nozzle LED: Three in one Gun Body LED: Quad
	Power per LED	Nozzle LED: 9 W Gun Body LED: 0.5W
	Total LED Power	Nozzle LED: 36 W Gun Body LED: 33 W
Capacity	Fluid Tank Capacity	330 ml
Output	Adjustable Output	×
	Max Fog Output Volume	Appr. 100 ml/min
	Maximum Continuous Duration (100% Output)	Appr. 20,000 cuft/min
	Max Output Distance	Appr. 8m
	Fluid Consumption (100% Output)	Appr. 30s
Placement & Mounting	Horizontal	√
	Inclined	×
	Sidelong	×
	Hang Upside Down	×
	Rigging & Trussing	√
Control	On-device Manual Control	LCD
	Wireless Control	×
	Wired Control	×
	DMX512	×
Consumable	Consumable	PRO-Q
Weight & Dimensions	Net Weight	13.75 kg
	Gross Weight	29.8 kg
	Gun Body Dimension	754 × 302 × 135 mm
	Bottom Base Dimension	570 × 199 × 174 mm
	Flight case Dimension	830 × 620 × 250 mm

4 SETUP

4.1 AC Power

The machine has a fixed voltage power supply and can work with an input voltage of AC 220 V-240 V, 50/60 Hz.

To determine the product's power requirements (circuit breaker, power outlet, and wiring), use the current value listed on the label affixed to the product's back panel, or refer to the product's specifications chart. The listed current rating indicates the product's average current draw under normal conditions.



Always connect the product to a protected circuit (circuit breaker or fuse). Make sure the product has an appropriate electrical ground to avoid the risk of electrocution or fire.



Never connect the product to a rheostat (variable resistor) or dimmer circuit, even if the rheostat or dimmer channel serves only as a 0 to 100% switch.

5 OPERATION

Before using the product, read and follow the safety recommendations indicated in the Safety Notes.

5.1 How to install the fluid tank

As shown in below Figure 1, hold the left and right Rear Buttons, slide the Rear backward. Tilt the fluid tank and install it into the groove.

As shown in below Figure 2, after installation, push the Rear forward and fix the fluid tank.

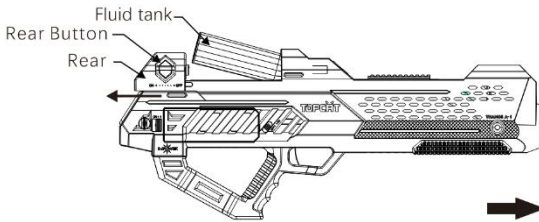

Fluid tank installation drawing 1

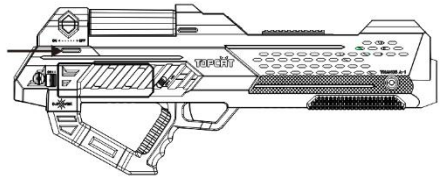

Fluid tank installation drawing 2

5.2 How to install the battery

As shown in below figures, insert the battery into the cabinet until it is locked firmly by quick Lock#A and B.

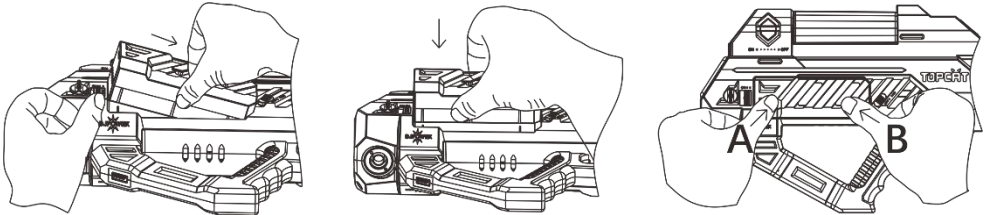

5.3 How to remove the battery

As show in the below figure 1, push up Lock#B and pull back Lock#A together to unlock the battery.

After the battery pops up, Lock#A and Lock#B will reset automatically as shown in the below figure 2.

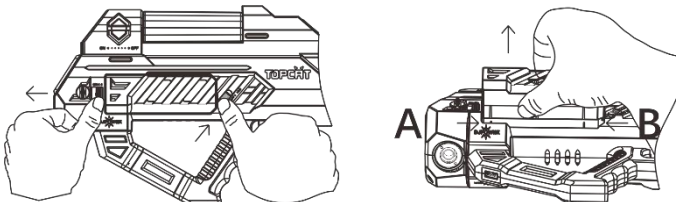



Precautions:

1. Keep the battery away from flammable materials.
2. Do not charge with a current greater than 5C. Make sure someone is present when charging.
3. Do not store the battery on unused machines for a long time.
4. Do not disassemble or incinerate the battery.
5. For environmental protection, properly dispose of used batteries.

5.4 How to heat the Fog Gun

Place the A-1 fog gun on the Power Base, ensure it is correctly engaged. Power on the Bottom Base to heat the fog gun.

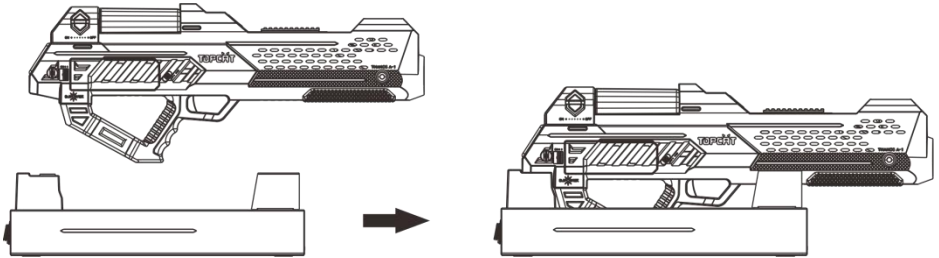

During heating, the LCD display shows " Heating up ", the LEDs inside two Trigger Buttons flicker. When the heating is finished, the LEDs turn blue and LCD display shows the fog duration.

After the fog gun is heating up for 1 minute on the Power Base, it will enter into power saving mode with the LED strips on the gun body black out and LCD display blacks out also.

LCD display and LED strips light on again when removing the fog gun from the base or pressing any buttons on the LCD display or triggering fog.

Note: In the power saving mode, heating up is still in process as long as the the gun's temp has not reached to the required.



Introduction to Power Base:

Connect the power cable into a power outlet (AC 220V ~240V), power on the bottom base. The LED strips on the bottom base light on with colors changing randomly. Place the A-1 fog gun on the power base, the unit starts heating. When the gun body is attached to Power Base for 3 hours, heating protection shall be activated. LED strips on the based shows RED and keeps flickering, meanwhile the Heating Protection Switch shows blue and LED flickers. To release the protection, simply press Heating Protection Switch.

5.5 How to charge battery

The Bottom Base provides two Charging Rooms.

Remove the battery from the Gun Body and insert it into the Charging Room as show in below picture 1.

Then lock the battery through the Blocker as show in the picture 2.

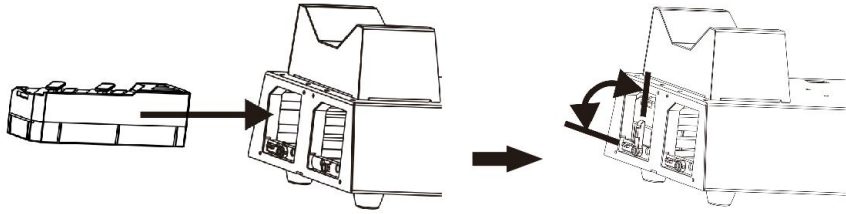

Power on the Bottom Base to start charging. After fully charged, release the Blocker to eject the battery.

Make sure the Bottom Base is powered on during battery charging. The digital display above the charging area shows the battery voltage. "FUL" means the battery is fully charged.

⚠ Note:

1. Please remove the battery from the charging room in case the Bottom Base is powered off. Do not leave the batteries inside the base for a long time.
2. When the digital display shows E11 during charging, please remove the battery and put it back. In case the error code still shows, please change to another charging room.

5.6 On-device Control Mode & Operation

5.6.1 On-device Control

To access the control panel functions, use the four buttons located underneath the LCD display.

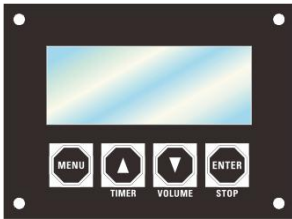

Button	Function
<MENU>	Switch menu pages to select a function
<▲>	Increases the numeric value of current function
<▼>	Decreases the numeric value of current function
<ENTER>	Save settings

5.6.2 Menu Map

	Display	Description	Parameter Range
Welcome Pages	TOPCAT A-1		
Preparing Pages	Heating up Battery: 100%	The units is heating up. Indicating the battery power.	
	Heating up stopped Battery: 100%	In case the power is stopped before the fog gun is well heated, it shows heating stopped. Indicating the battery power.	

Standby Page	Fog Output 30S Battery: 100%	Heating is finished. Fog output duration is 30s Indicating the battery power.	
		Place the Gun Body on the Power Base. In case the temp has not reached the required running temp, the LCD display shows "heating up". When the temp reaches the required, it will show "Fog Output 30", means it is ready to work.	
	Strong Wind ON	Press "▲" or "▼" to switch on/off the fan installed in the muzzle.	ON/OFF
	Fog Color: OFF	Press "▲" or "▼" to set the LED color installed around the nozzle	OFF 1=RED 2=GREEN 3=BLUE 4=YELLOW 5=PURPLE 6=SKY BLUE 7=AUTO COLOR
Setting Pages	Gun Body Color Auto	Press "▲" or "▼" to set the LED color installed in the gun body.	1=RED 2=GREEN 3=BLUE 4=PURPLE 5=YELLOW 6=SKY BLUE 7=WHITE AUTO COLOR
	Trigger: 1	Press "▲" or "▼" to set the Trigger functions 1 means: Hold the Trigger only to spray fog. 2 means: Hold the Trigger and two Trigger Buttons by the sides of the nozzle together to spray fog. In such case, if holding the Trigger only, the high-speed fan in the nozzle can work.	1 or 2
	Fluid sensor OFF	Press "▲" or "▼" to turn on/off No-fluid protection function.	ON/OFF

6 TECHNICAL INFORMATION

6.1 Maintenance

- 1、 Please use DJPOWER PRO-C Fog Fluid to ensure the best performance and effect.
- 2、 Any reference to servicing in this User Manual will only apply to properly trained, certified technicians. Do not open the housing or attempt any repairs which can lead to damage or malfunction.
- 3、 Excessive dust, fluid residue and dirt will degrade performance and cause overheating. Remove dust from air vents with air compressor, vacuum or soft brush. The casing could be cleaned by the damp cloth.

6.2 Storage

6.2.1 Machine Storage

Before storing the machine, clean it and empty the fluid tank.

6.3 Troubleshooting

Errors	Symptom	Potential Cause	Solution
No fluid	Refer to "MENU MAP" chapter to for more information	No fluid in the tank	Refill the fluid
		Pump problem	Contact dealer for Service
Heating failure	Refer to "MENU MAP" chapter to for more information	Heater problem	Contact dealer for Service

